

# FLEXA®

7121113/14/15  
7121213/14/15

22 x 186/196 x 95 cm

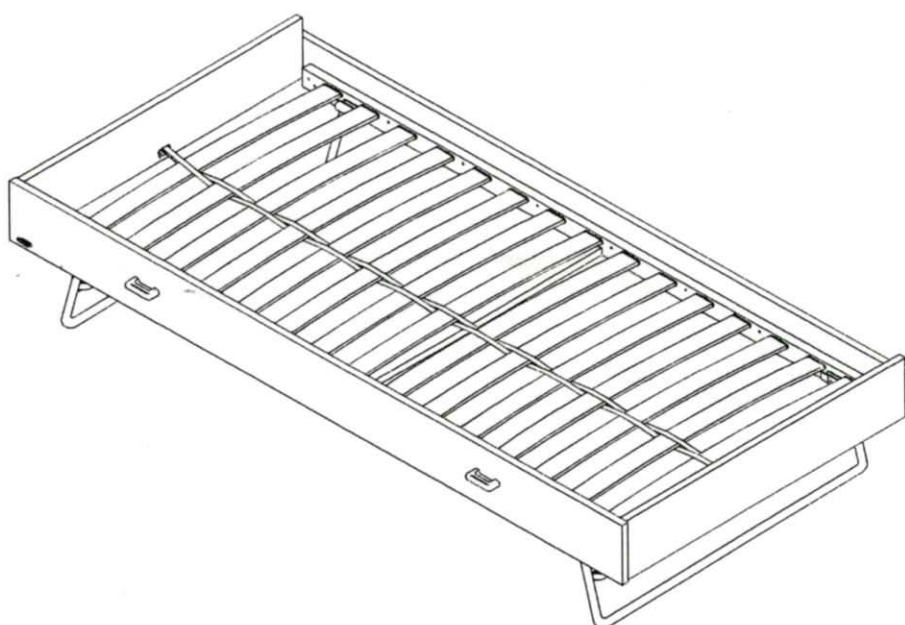

Monterings- og brugsvejledning  
Assembling instructions and  
directions for use

Montageanleitung und  
Gebrauchsanweisung

Notice de montage et mode  
d'emploi

Instrucciones de montaje y uso  
Montagehandleiding

Istruzioni per montaggio e per  
l'uso



2/February 2003

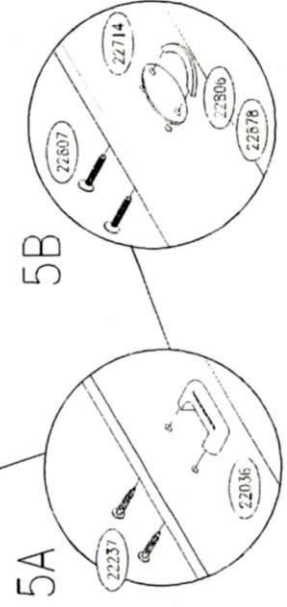
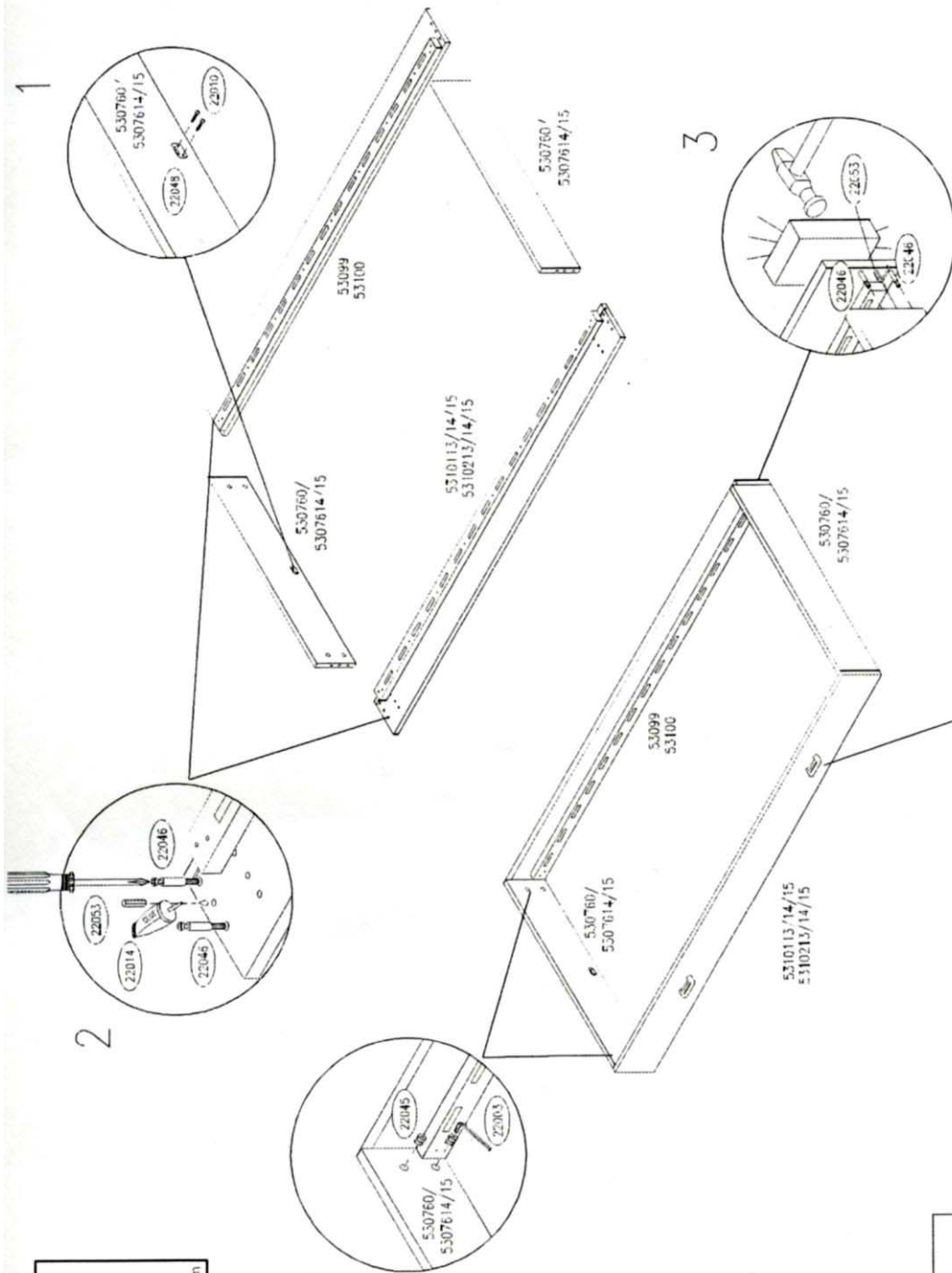

22003 x 1 	4 mm	22912 x 2 	22046 x 8 	6x15 mm	22048 x 2 	25x35 mm	22053 x 4 	8x30 mm
22010 x 4 	3,5x16 mm PH	22050 x 30 	22024 x 2 	30x40 mm	22006 x 20 	4,5x20 mm PH	22014 x 1 	15x15 mm
22113 x 1 	15x4250 mm	22044 x 1 	22011 x 1 	24x6,5 mm	22045 x 8 	712115 / 7121215 22878 x 2 	22807 x 4 	14x25 mm
712113 / 7121213 22036 x 2 	712114 / 7121214 22806 x 2 	22037 x 4 	22807 x 4 	14x25 mm	22714 x 2 	22011 x 2 	22011 x 2 	53099 53100 530760 / 5307614/15
22003 x 1 	4 mm	22912 x 2 	22046 x 8 	6x15 mm	22048 x 2 	25x35 mm	22053 x 4 	8x30 mm

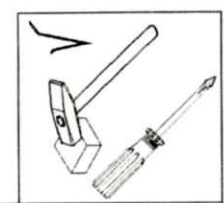
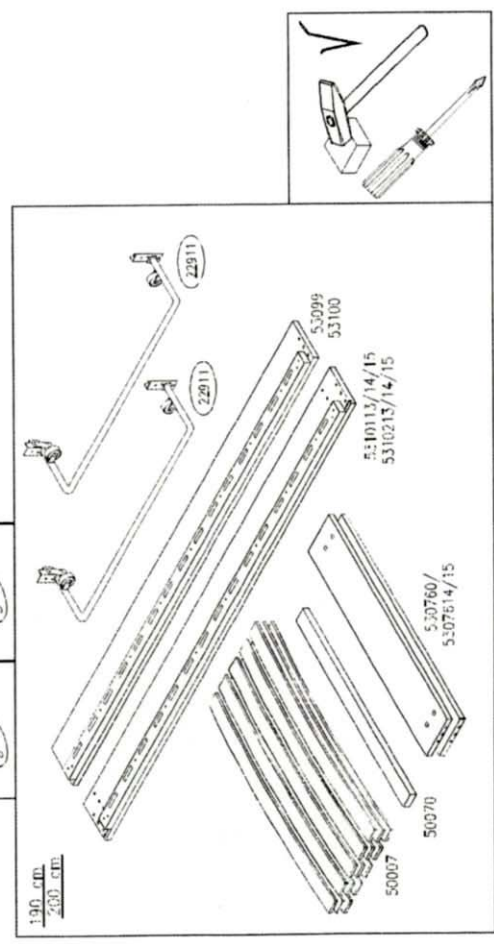

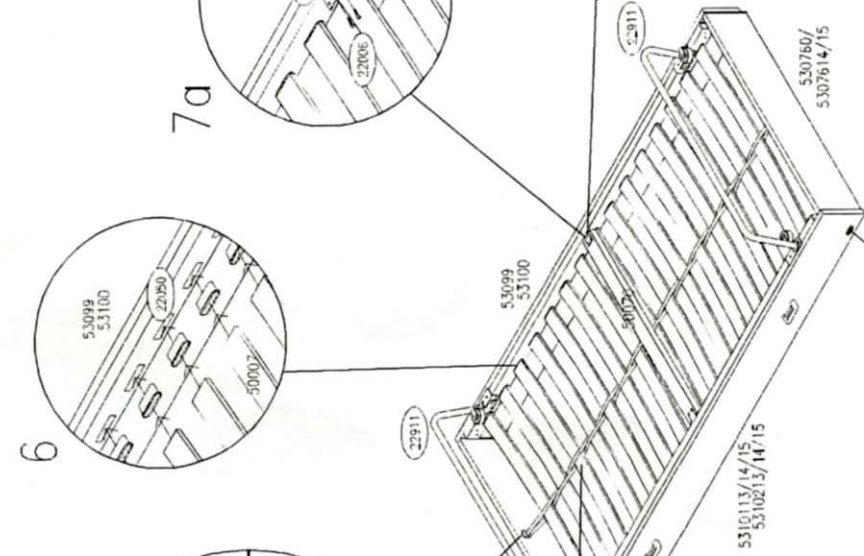
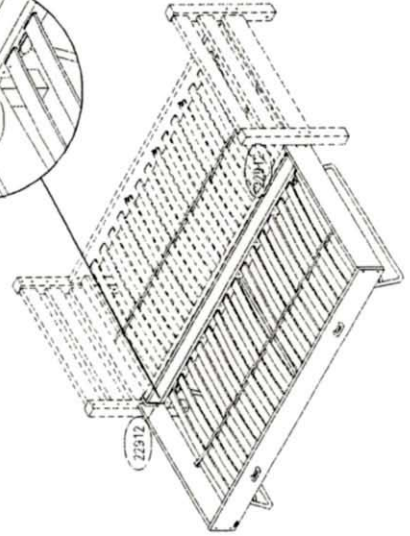
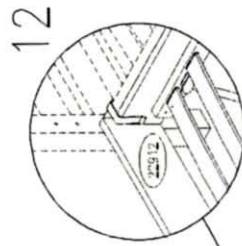
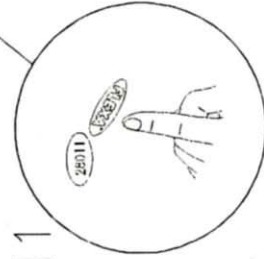
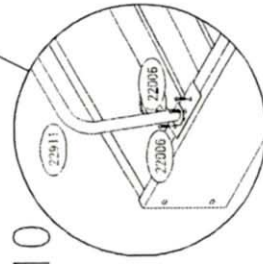
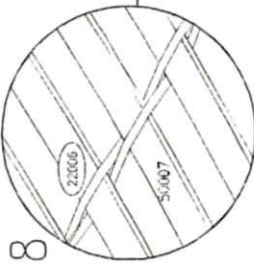
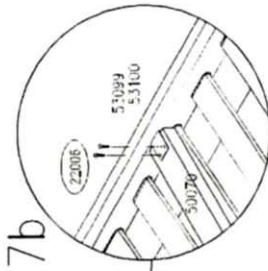
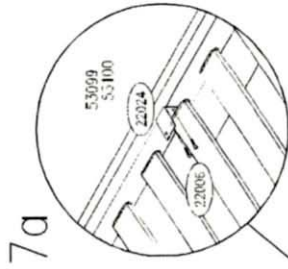
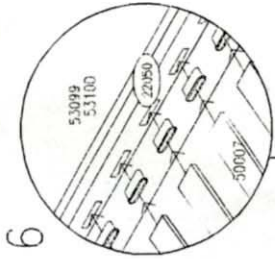
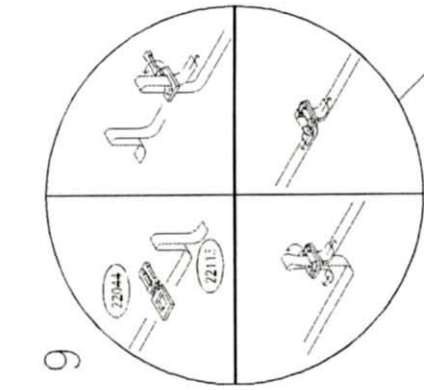
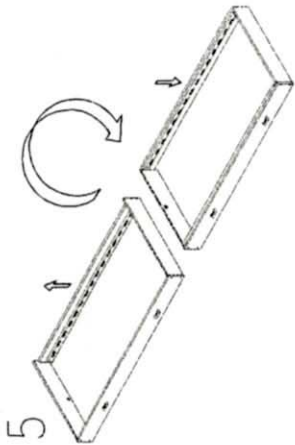

(DK)	<b>RÅD OM VEDLIGEHOLDELSE:</b> For at med en tægt hånd, f.eks. sætte pløtter fast med en fugt svamp med små- eller store huller. Skruer og bolte spændes med jævne mellemrum.	(GB)	<b>MAINTENANCE INSTRUCTIONS:</b> Cleaning with a wet cloth, use a sponge with soap to remove chemicals and oil. Screws and bolts should maintain their tightness.	(D)	<b>PFLIE-RHINDES:</b> Reinigen mit einer feuchten Lappen. Für Korrosionen schützen: angetrocknete kleine Schrauben mit feiner Schwamm mit kleinen Löcherchen und mit Öl befeuchten. Die Löcherchen- und Schrauben sollten regelmäßig nachgezogen werden.	(F)	<b>CONSEILS D'ENTRETIEN:</b> Entretien avec un chiffon humide pour la poussière - les taches salées s'effacent avec une éponge perforée avec de petites ouvertures. Évitez tout contact avec l'alcool, le vernis, les produits chimiques. Vérifiez régulièrement les vis.	(E)	<b>CONSEJO PARA LA CONSERVACION:</b> Limpiar con un paño húmedo. Para quitar manchas saladas o de aceite, usar una esponja con agujeros pequeños. Evitar usar alcohol, barniz, productos químicos. Necesitan apretarse a veces.	(NL)	<b>ONDERHOUD:</b> Reinigen met een vochtige doek. Hardnekkig vuil verwijderen met een spons met kleine gaatjes. Vermijd alcohol- en verdundingsmiddelen. Schroeven en moeren regelmatig aandraaien.	(I)	<b>CONSIGLI PER LA MANUTENZIONE:</b> Pulire con un panno umido, usare una spugna inorganica di spugna per togliere lo sporco persistente. Evitare l'uso di prodotti chimici. Controllare e sfilare, di tanto, di tanto, di ri-avvitare.
------	--	------	--	-----	---	-----	--	-----	--	------	--	-----	--